

ÜBERSICHTSZEICHNUNG
ASSEMBLY DRAWING

LAPIERRE



ZESTY CF 6.9 / 7.9 / 8.9 / 9.9 / SE (MY24)



ZESTY CF 6.9 / 7.9 / 8.9 / 9.9 / SE (MY24)

date: 25-01-2024

version: 01

ÜBERSICHTSZEICHNUNG
ASSEMBLY DRAWING main frame

LAPIERRE

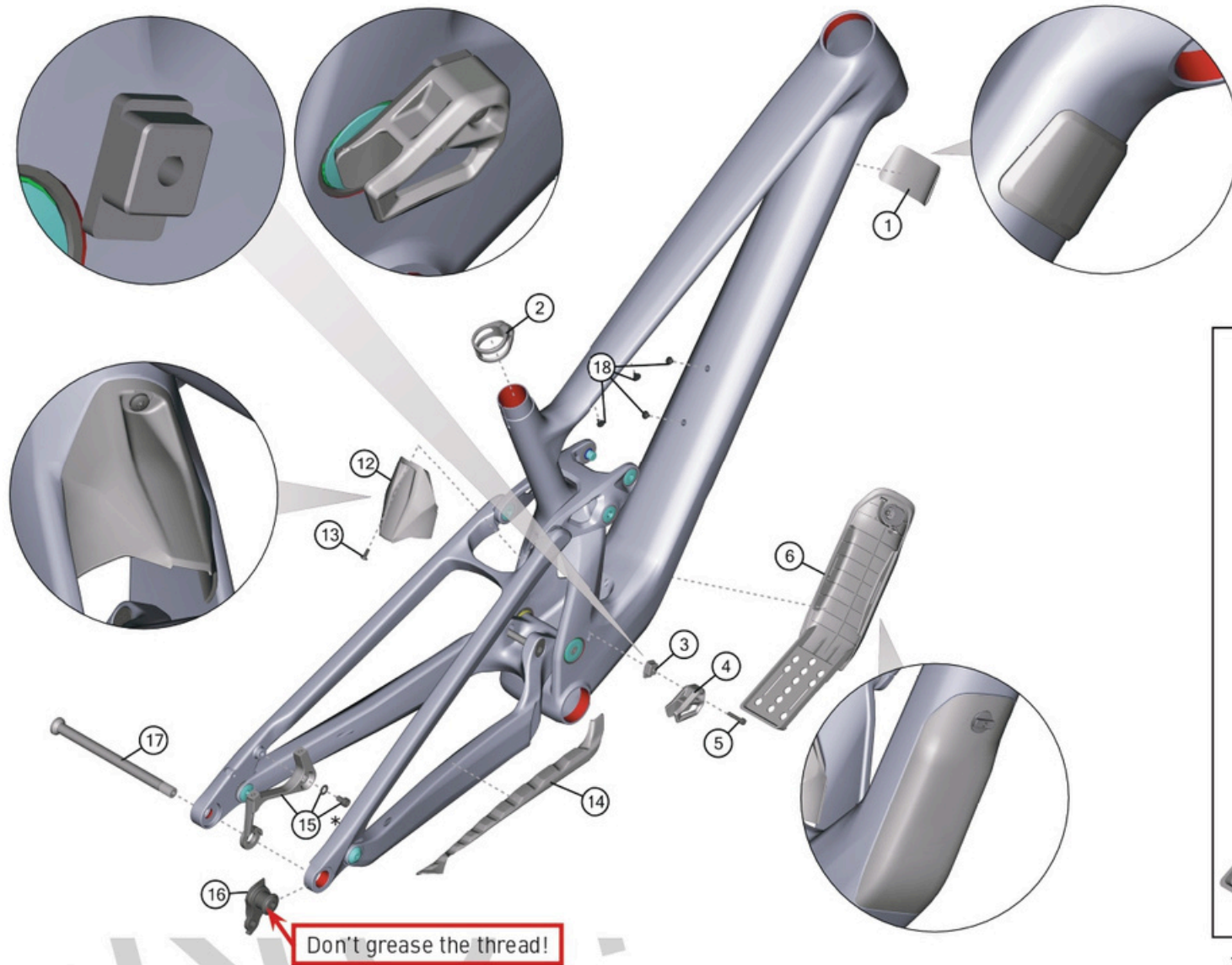

Hinweis: Bei den Schrauben muss mittelfeste Gewindesicherung verwendet werden. Rote Flächen müssen gefettet werden.

Note: use medium strength screw lock for screw threads. Red surfaces have to be greased.





















ZESTY CF 6.9 / 7.9 / 8.9 / 9.9 / SE (MY24)
date: 25-01-2024
version: 01



ÜBERSICHTSZEICHNUNG

ASSEMBLY DRAWING main frame

LAPIERRE

BOM-ID	Item nr.	QTY	Description	Specification	Torque	
1	10031378	1x	Fork bumper			KLP00042 
2	10010773	1x	Seat clamp incl. screw M5x12mm	∅ 34,9 mm	6 Nm	
3	10031452	1x	Chain guide bracket			KLP00039 
4	10031449	1x	Chain guide			KLP00039 
5	10031451	1x	Cylinder head screw	HS3 - M4 x 20 mm	3 Nm	KLP00039 
6	10031343	1x	Toolbox (assembled set)			KLP00064 
7	included in Pos. 6	1x	Toolbox			KLP00043 
8	included in Pos. 6	1x	Toolbox lever			KLP00066 
9	included in Pos. 6	1x	Toolbox lock mechanism			KLP00066 
10	included in Pos. 6	1x	Spring toolbox lock mechanism			KLP00066 
11	included in Pos. 6	1x	Toolbox lever screw			KLP00066 
12	10031345	1x	Shock fender long			KLP00017 
13	10031385	1x	Lens head screw	TX20 - M4 x 10 mm	1 Nm	KLP00017 
14	10031344	1x	Chainstay protector			KLP00016 
15*	10031386	1x	Brake mount adapter incl. cylinder head screw M6x16mm + washer		10 Nm	KLP00064 
15*		1x	Brake mount adapter	PM180	10 Nm	KLP00015 
16	10010774	1x	UDH derailleur hanger + nut	Don't grease the thread!	25 Nm	
17	10017878	1x	Rear Thru-axle			KLP00026 
18	10012933	4x	Bottle hanger bolts			-



ZESTY CF 6.9 / 7.9 / 8.9 / 9.9 / SE (MY24)

date: 25-01-2024

version: 01

ÜBERSICHTSZEICHNUNG

ASSEMBLY DRAWING rockerlink

LAPIERRE

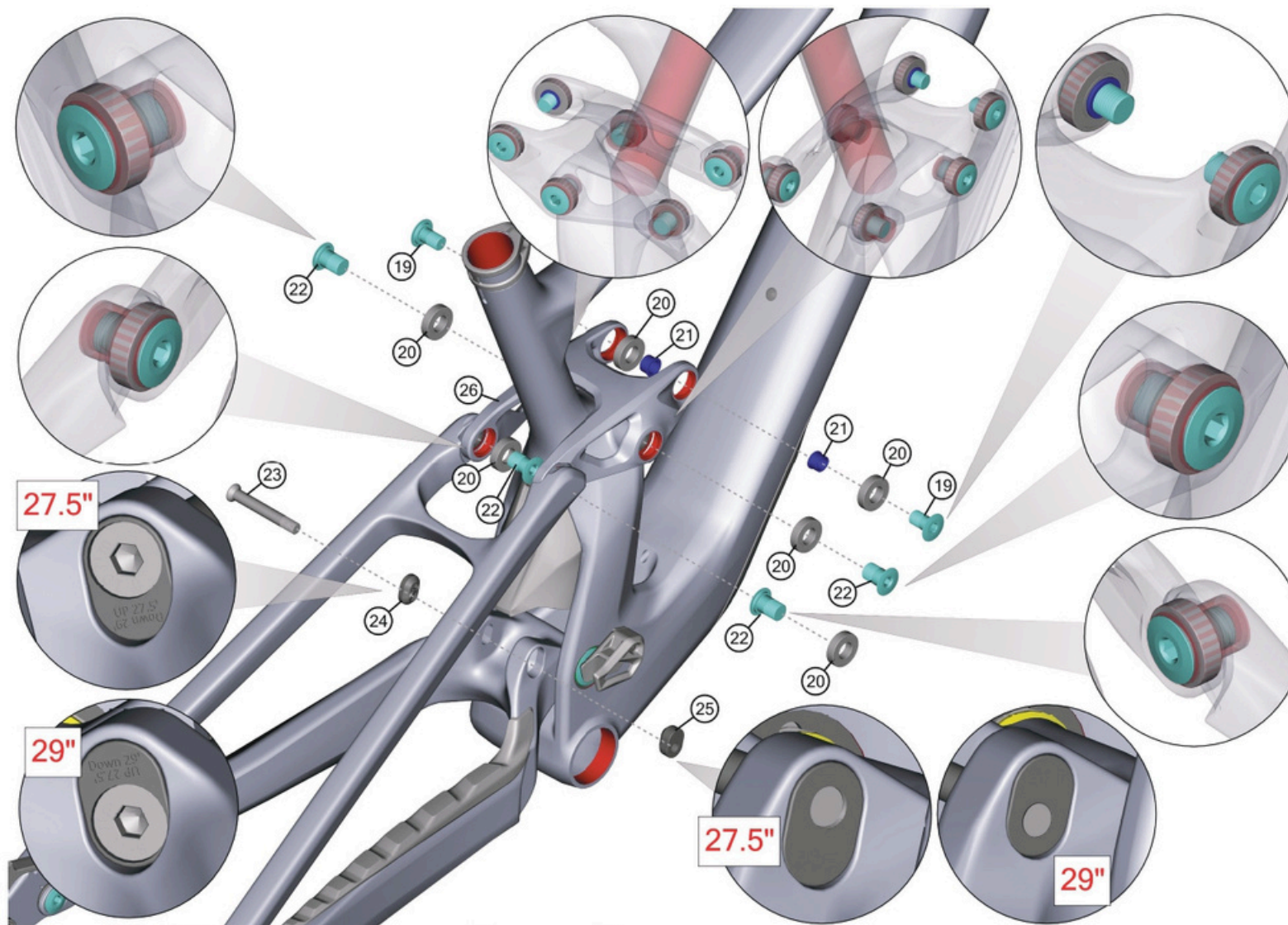

Hinweis: Bei den Schrauben muss mittelfeste Gewindesicherung verwendet werden. Rote Flächen müssen gefettet werden.

Note: use medium strength screw lock for screw threads. Red surfaces have to be greased.











ZESTY CF 6.9 / 7.9 / 8.9 / 9.9 / SE (MY24)
date: 25-01-2024
version: 01

ÜBERSICHTSZEICHNUNG

ASSEMBLY DRAWING rockerlink

LAPIERRE

BOM-ID	Item nr.	QTY	Description	Specification	Torque	
19		2x	Trunnion screw	HS6 - M10xp1.0x15.5 mm	8 - 10 Nm	KLP00069 
20		6x	Link bearing	6901-2RS - 24x12x6 mm		KLP00037 
21		2x	Trunnion bushing	Ø 12x10x7.5 mm		KLP00069 
22		4x	Link screw	HS6 - M12xp1.25x15 mm	16 - 18 Nm	KLP00069 
23		1x	Flipchip screw	HS5 - M8 x 59 mm	8 - 10 Nm	KLP00069 
24		1x	Flipchip spacer			KLP00069 
25		1x	Flipchip nut	M8		KLP00069 
26		1x	Link			KLP00052 



NOT FINAL

ZESTY CF 6.9 / 7.9 / 8.9 / 9.9 / SE (MY24)

date: 25-01-2024

version: 01

ÜBERSICHTSZEICHNUNG

ASSEMBLY DRAWING

mainpivot / chainstay-seatstay

LAPIERRE

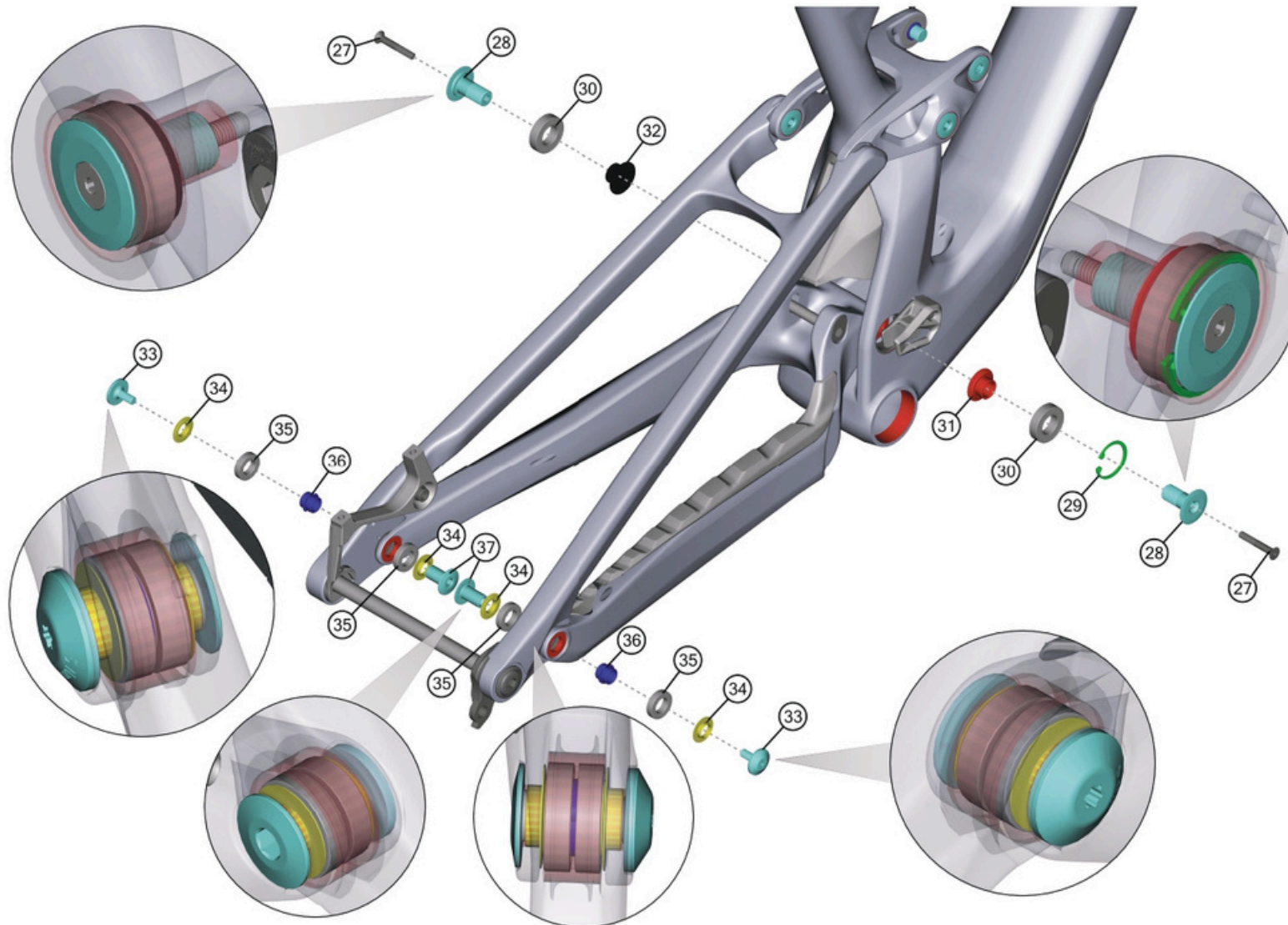

Hinweis: Bei den Schrauben muss mittelfeste Gewindesicherung verwendet werden. Rote Flächen müssen gefettet werden.

Note: use medium strength screw lock for screw threads. Red surfaces have to be greased.



ZESTY CF 6.9 / 7.9 / 8.9 / 9.9 / SE (MY24)

date: 25-01-2024











version: 01

ÜBERSICHTSZEICHNUNG

ASSEMBLY DRAWING

mainpivot / chainstay-seatstay

LAPIERRE

BOM-ID	Item nr.	QTY	Description	Specification	Torque	
27		2x	Mainpivot locking screw	HS3 - M5x35 mm	4 Nm	KLP00062 
28		2x	Mainpivot screw	HS6 - M12xp1.25x24 mm	18 - 20 Nm	KLP00062 
29		1x	Mainpivot circlip	Ø 30 mm		KLP00062 
30		2x	Mainpivot bearing	6902-2RS - 28x15x7 mm		KLP00037 
31		1x	Mainpivot spacer right side (red bushing)	Ø 15x12x9.5 mm		KLP00062 
32		1x	Mainpivot spacer left side (black bushing)	Ø 15x12x10.5 mm		KLP00062 
33		2x	Chainstay-seatstay screw	TX25 - M6xp1.0x15 mm	5 Nm	KLP00041 
34		4x	Chainstay-seatstay washer	Ø 12x10x3.8 mm		KLP00041 
35		4x	Chainstay-seatstay bearing	6801-2RS - 21x12x5 mm		KLP00037 
36		2x	Chainstay-seatstay spacer	Ø 12x10x10.5 mm		KLP00041 
37		2x	Chainstay-seatstay axle	HS6 - Ø 10x17.5 mm		KLP00041 



NOT FINAL

ZESTY CF 6.9 / 7.9 / 8.9 / 9.9 / SE (MY24)

date: 25-01-2024

version: 01

ÜBERSICHTSZEICHNUNG

ASSEMBLY DRAWING

LAPIERRE

FACT SHEET:	
SHOCK LENGTH:	205 x 60 mm
SHOCK HARDWARE TOP:	Trunnion Mount
SHOCK HARDWARE BOTTOM:	30mm bushing M8
HEADSET TOP:	ZS 56
HEADSET BOTTOM:	ZS 56
SEATPOST DIAMETER:	31,6 MM
CLAMP INNER DIAMETER:	34,9 MM
BOTTOM BRACKET:	Pressfit 92
KICKSTAND:	-----
ISCG STANDARD:	-----
CARRIER MOUNT:	NO
FENDER COMPATIBLE:	NO

DROPPER SEATPOST READY:	YES
WATERBOTTLE MOUNT:	1x Downtube / 1x Toptube
MAXIMUM PERMISSIBLE TOTAL WEIGHT:	120 KG (Cat. 4)
MAXIMUM TIRE SIZE:	29" x 2.5"
WHEEL SIZE:	27.5" / 29"
QUICK RELEASE LENGTH:	177,5 MM
OVER-LOCKNUT DIMENSION (O.L.D.):	148 MM
FD CLAMP SIZE:	-----
FD TYPE:	-----
ENGINE:	-----
BATTERY:	-----
DISPLAY:	-----



ZESTY CF 6.9 / 7.9 / 8.9 / 9.9 / SE (MY24)

date: 25-01-2024

version: 01